

KIT INVERTER ASSEMBLY

100043-5, 8, and 11

| | | | |
|---|---|---|---|
|  <p>Installation and servicing of Danfoss Turbocor® compressors by qualified and product trained personnel only. Follow these instructions and sound refrigeration/electrical/servicing practices relating to installation, commissioning, maintenance and service.</p> | | | |
| <p>Consult the appropriate Danfoss Turbocor (DTC) Service Manual on turbocor.danfoss.com for detailed service instructions.</p> | <p>Never power compressor without covers in place and secured.</p> <p>Removing the mains input cover will expose you to a voltage hazard of up to 575V. Ensure the mains input power is off and locked out before removing cover.</p> <p>Before removing top cover, wait at least 20 minutes after isolating AC power to allow the high voltage capacitors to discharge.</p> | <p>Always wear appropriately rated safety equipment when working around equipment and/or components energized with high voltage.</p> <p>This equipment contains hazardous voltages that can cause serious injury or death.</p> | <p>Recover all refrigerant from compressor in accordance with local codes and ensure pressure is fully vented before the removal of refrigerant containing components.</p> |

1 - Introduction:

INVERTER ASSEMBLY replacement.

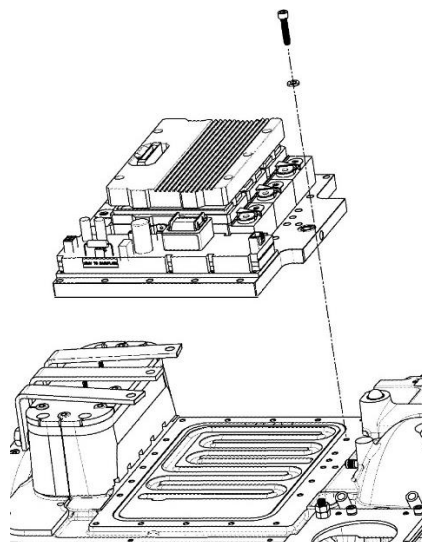

This kit contains the Inverter, O-rings, and fasteners. Please refer to our Service Manual for details regarding the replacement of the Inverter.

We have made the **TTS/TGS/TTH/TGH Service Manual** available to anyone. To access the manual, you may scan the applicable QR code below or you may go to our DTC website at www.turbocoroem.com. At the top of the page there is a pull-down menu called "Quick Links." Click this menu and select the appropriate service manual.

Refer to the applicable QR code below to download the TTS/TGS/TTH/TGH Service Manual.

English**Chinese**

2 - INVERTER ASSEMBLY Removal Instructions:

1. Isolate compressor power as described in Section "Electrical Isolation of the Compressor" of the Service Manual (M-SV-001).
2. Isolate the compressor and recover the refrigerant according to industry standards.
3. Remove the top covers.
4. Remove the Capacitor Cover.
5. Remove the Soft Start.
6. Remove the AC mains input terminals and bus bars.
7. Carefully lift the DC Bus Bars and capacitors out as an assembly. Do not remove the bleed resistors or capacitors from the bus bars.
8. Remove the compressor cable harness.
9. Carefully remove the SCR Cooling Manifold from the Inverter Heat Sink Plate and the SCR Manifold Return Brass Fitting.
10. Disconnect all wiring connections from the DC-DC.

NOTE: There is no need to remove the DC-DC converter from the Inverter heat sink plate at this time.

11. Remove the Inverter from the compressor main housing.
12. Remove and discard the large Inverter O-ring from the compressor housing.
13. Remove and discard the two (2) O-rings from the SCR Manifold Return Brass Fitting.
14. Remove the DC-DC Converter from the Inverter Heat Sink Plate.

3 - Inverter Assembly Installation Instruction:

1. Clean O-ring groove in the main compressor housing and SCR Manifold Return Brass Fitting with a lint-free cloth.
2. Apply O-lube and install the O-rings SCR Manifold Return Brass Fitting.
3. Apply O-lube and install the Inverter O-ring in the compressor housing groove.
4. Install the DC-DC Converter.







NOTE: Installing the DC-DC Converter at this point will ease installation rather than waiting until the Inverter assembly has been installed onto the compressor.

5. Remove the backing material from the Inverter Heat Sink Plate of the new Inverter. Use caution to not damage the bottom sealing surface of the Inverter.
6. Install the new Inverter assembly.
7. Clean the O-ring groove on top of the Inverter Heat Sink Plate with a lint-free cloth.
8. Apply O-Lube to the provided SCR Heat Sink O-ring and place in the O-ring groove in the Inverter Heat Sink Plate and install.
9. Apply O-lube to the two (2) new O-rings on the SCR Manifold Return Brass Fitting and install.
10. Carefully install the SCR cooling plate over the SCR Manifold Return Brass Fitting.

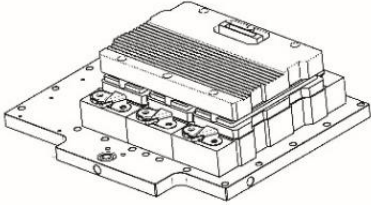
NOTE: Before proceeding, ensure that the SCR Cooling Plate is fully seated onto the SCR Manifold Return Brass Fitting.

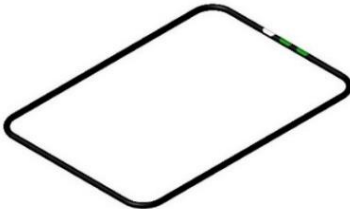
11. Install the compressor cable harness.
12. Install the DC Bus Bar and Capacitor assembly.
13. Connect all electrical connections to the DC-DC Converter.
14. Install the Mains Input Terminals.
15. Install the Soft Start.
16. Install the Capacitor Cover.
17. Install the top covers.
18. Leak test and evacuate compressor in accordance with standard industry practices.
19. Return the compressor to normal operation.

4 - Kit Contents:

| KIT | 100043-5, -8, and -11 | |
|-----|-----------------------------|---|
| QTY | Part(s) Description | Picture(s) |
| 1 | INVERTER ASSEMBLY |  |
| 1 | O-RING #2-112 |  |
| 2 | O-RING #2-113 |  |
| 1 | O-RING #2-377 |  |
| 1 | LUBRICATION-SUPER-O-LUBE-2G |  |
| 18 | WASHER M6 FLAT |  |
| 18 | SCREW M6X30 SOCKET HEAD CAP |  |
| 4 | SCREW M6X35 SOCKET HEAD CAP |  |

Danfoss can accept no responsibility for possible errors in catalogues, brochures, and other printed material. Danfoss reserves the right to alter its products without notice. This also applies to products already on order provided that such alterations can be made without consequential changes being necessary in specifications already agreed. All trademarks in this material are property of the respective companies. Danfoss and the Danfoss logotype are trademarks of Danfoss A/S. All rights reserved.